

---

## CCAT-prime (CCAT-p): A Novel Telescope at a Superb Site for Cosmology and Spectroscopy

CCAT-prime (CCAT-p) will be a 6-meter (20 feet) diameter telescope located at 5600 meters (18,400 feet) elevation on Cerro Chajnantor in the high Atacama Desert of northern Chile. Situated at a high, dry site and with a surface accuracy of better than  $10\ \mu\text{m}$  (0.0004 inches;  $1\ \mu\text{m} = 1\ \text{micron} = 1\ \text{micrometer}$ ), CCAT-p will observe the sky at submillimeter to millimeter wavelengths. A novel “crossed-Dracone” optical design will deliver a high-throughput, wide-field-of-view telescope capable of illuminating more than 100,000 detectors enabling rapid mapping of large areas of the sky. The high site offers superb observing conditions, yielding routine access to the  $350\ \mu\text{m}$  window and improved performance at longer wavelengths. Deployment of the CCAT-p telescope and instrumentation on Cerro Chajnantor will provide operational experience at high altitude, reducing risk for the future construction of a 25-meter class telescope at the same site.

Submillimeter astronomy studies light with wavelengths ( $\lambda$ ) of about  $200\ \mu\text{m}$  to 1 millimeter, bridging a range between the more traditional optical/infrared and radio bands. Because water vapor molecules in the Earth’s atmosphere absorb most of the incoming cosmic submillimeter photons, submillimeter telescopes must be located at the highest, driest telescope sites. In addition to its location at a superb site, CCAT-p’s bold optical design positions it to take advantage of an on-going wave of advancement in detector array technology, making it a truly next-generation submillimeter telescope.

Cosmic sources of submillimeter radiation include the dark cold molecular clouds and the dusty regions where stars and planets form, both of which are invisible to optical telescopes because the surrounding dust absorbs the embedded stellar photons and re-radiates their energy in the submillimeter. Distant supermassive black holes and galaxies forming stars at an enormous rate are also often dust-enshrouded and optically “dark” but are discoverable by submillimeter telescopes. The oldest light in the Universe, the Cosmic Microwave Background (CMB), is another rich source of radiation.

A partnership of Cornell University, a consortium of German institutions led by the Universities of Köln and Bonn, and a consortium of eight Canadian academic institutions are working together to create CCAT-p. Researchers at additional institutes in the U.S., Canada, Germany and Chile are involved in science planning and instrument development. CCAT operates in Chile under a Cooperative Agreement with the University of Chile and under the auspices of the Ministry of Foreign Affairs.

## Telescope Design Requirements and Goals

Aperture	6 meters in diameter
Wavelength range	$\lambda = 200$ micrometers ( $\mu\text{m}$ ) to 3 millimeters (mm)
Field of view	8 degrees at $\lambda = 3$ mm; 4 degrees at $\lambda = 1$ mm
Half wave front error	10.7 $\mu\text{m}$ rms with goal of 7 $\mu\text{m}$ rms
Offset pointing	Better than 2.7 arcsec rms with goal of 1.8 arcsec rms
Scan pointing knowledge	Better than 1.4 arcsec rms with goal of 0.9 arcsec rms
Pointing stability	Better than 1.4 arcsec rms with goal of 0.9 arcsec rms
Total blockage in optical path	Better than 1% with a goal of 0%



### Scientific Goals

The scientific goals of CCAT-p motivate its unique characteristics of wide-field, high surface accuracy, high throughput and high altitude location for major legacy programs:

- **SZ:** Measurement of the velocities, temperatures and transparencies of galaxy clusters via the Sunyaev-Zel'dovich ("SZ") effect to place new constraints on models of dark energy and modified gravity and the sum of the neutrino masses;
- **GEvo:** "Galaxy Evolution" studies of dusty star-forming galaxies going much deeper than those of the Herschel Space Observatory (3.5 meter telescope) in number counts and in directly resolving (and characterizing) the population of faint sources responsible for most of the cosmic far-infrared background;
- **IM/EOR:** Intensity mapping of the ionized carbon [CII] line ( $\lambda_{\text{rest}} = 158 \mu\text{m}$ ) from star-forming galaxies in the Epoch of Reionization (EOR) at redshifts of 5 to 9, looking back in time to within a few hundred million years after the Big Bang, to understand the topology and timescale of reionization and the processes responsible for it.
- **GEco:** "Galactic Ecology" studies in multiple spectral lines to measure the gas temperatures, densities and velocities of interstellar clouds, thereby tracing the processes by which stars and planets form in a wide range of different environments within the Milky Way Galaxy, the Magellanic Clouds and other nearby galaxies;
- **CMB:** Exquisitely precise mapping of the CMB radiation, including separation of its polarization components, offers the possibility to detect gravitational waves from the epoch of inflation in the first tiny fraction of a second after the Big Bang. CCAT-p will work in concert with other telescopes located at lower sites and focusing on millimeter to centimeter wavelengths, bringing to next generation CMB efforts the in-depth understanding of the CMB and the impact of Galactic dust on CMB measurements.

## Telescope Design and Construction

Vertex Antennentechnik GmbH of Duisburg, Germany is designing and constructing the CCAT-p telescope. First light is scheduled for 2021.

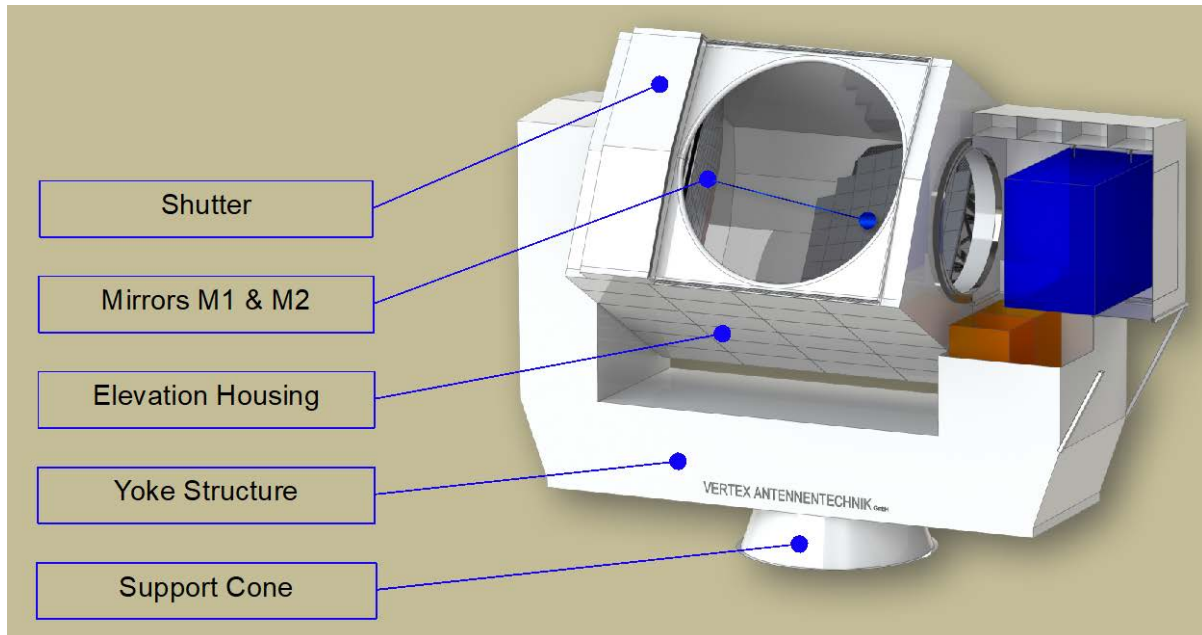

### A New Technology Telescope

The technical challenges required for highly efficient wide-area mapping in the submillimeter and millimeter wavelength range have led Cornell professor Mike Niemack to propose that the CCAT-p telescope use a “cross-Dragone” approach to its optical design (see sketch to the right). This design focuses the incoming light over a flat area that can accommodate cameras containing very large numbers of detectors. Current detector arrays, such as those used in the Atacama Cosmology Telescope (ACT) and the South Pole Telescope (SPT) consist of thousands of detectors. In contrast with current cameras, CCAT-p will make use of novel advances in detector array technologies, allowing hundreds of thousands to millions of detectors to be placed in the focal plane.

In addition, the Dragone design greatly reduces telescope-induced polarization, which is critical for CMB experiments.

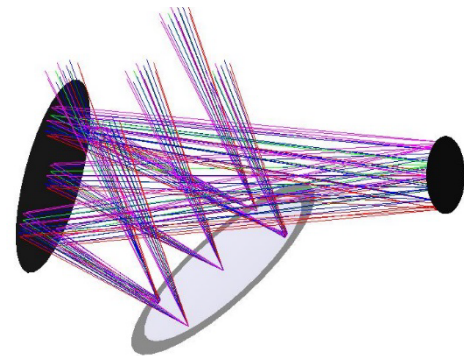

**Example optical layout of a crossed-Dragone telescope.** Light from the sky is reflected by a primary mirror (center) and to a slightly smaller secondary (left) before reaching the instrument port on the side (right). This mirror combination permits a highly efficient throughput of the light over a very wide field of view and delivers a flat focal plane that will accommodate hundreds of thousands to millions of detectors. The basic concept was presented in Niemack (2016, *Appl. Optics*, 55, pp. 1688-1696; [arXiv/1511.04506](https://arxiv.org/abs/1511.04506)).

## The Cerro Chajnantor site: high, dry and accessible

The CCAT team has been exploring sites for a submillimeter telescope in the Atacama region for nearly 15 years. For almost 10 years, we have been monitoring conditions on a flattened ledge about 70 meters below the summit of Cerro Chajnantor at an elevation of about 5600 meters. In 2014, the Chilean government granted a concession for the construction of a 25-meter telescope; the concession is being modified to accommodate CCAT-p (but the previously studied 25-meter telescope could be built there someday).

At 600 meters higher than the Chajnantor plateau, the CCAT-p site lies above the atmospheric layer containing most of the water vapor that absorbs millimeter and, especially, submillimeter photons. While ALMA and facilities lower down can operate at the shortest wavelengths only under the best conditions there, locating CCAT-p higher up allows a much larger fraction of time for observing at the shortest wavelengths and gives increased efficiency at longer ones.



View of the CCAT site from the summit of Cerro Chajnantor. ALMA is located on the Chajnantor plateau below.

In 2006, the CCAT team deployed a tipping water vapor radiometer, a device to measure the amount of water vapor in the atmosphere above it, at the CCAT site on Cerro Chajnantor. Several campaigns of weather balloon launches were also carried out (Giovannelli *et al.* 2001, PASP 113, 803). The figure on the bottom left shows the cumulative fraction of the time where the zenith optical depth, a measure of transparency, is better than a given value (smaller numbers indicate better transparency) at Mauna Kea (MK), the South Pole (SP), the Chajnantor plateau (CP) and Cerro Chajnantor (CC). It shows that, while the South Pole has a higher fraction on average, Cerro Chajnantor has a higher fraction of “best” conditions.

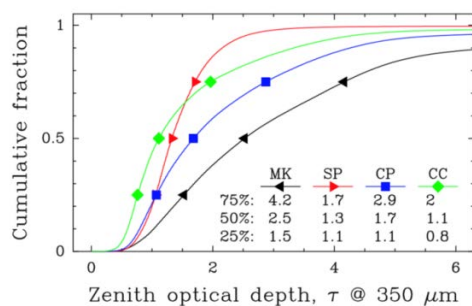

*Cumulative fraction of time that the zenith optical depth (a measure of transparency) at the short wavelength of 350  $\mu\text{m}$  is better than a given value. See text for a comparison between the various sites. From Radford & Peterson (2016).*

*Right: Weather balloons launched from the plateau record pressure, temperature, wind-speed and water vapor as they rise.*



Other measures of transparency at 350  $\mu\text{m}$  include the precipitable water vapor (PWV) of the atmosphere (measured in millimeters) and the scale height of the water layer (in meters). By both of these metrics, the 5600-meter site on Cerro Chajnantor is better a larger fraction of the time, thus giving much greater access to the shortest wavelengths than the lower sites.



## Precision cosmology with the Cosmic Microwave Background radiation

In 1965, Arno Penzias and Robert Wilson discovered the Cosmic Microwave Background (CMB) radiation, the relic of the Era of Recombination when free electrons and protons in the cooling universe combined to form hydrogen atoms about 380,000 years after the Big Bang. The temperature of the universe at that time was about 3000 degrees Kelvin (K). The CMB spectrum we see today reflects not only the temperature at that time, but also its large redshift ( $z \sim 1000$ ), so that the observed CMB spectrum has an apparent temperature of 2.725 K, almost-but-not-quite the same in all directions. Measurements of the amplitudes and sizes of the slight deviations from the average temperature provide rich insight into conditions in the early universe and set stringent constraints on its evolutionary history, dark matter and dark energy content.

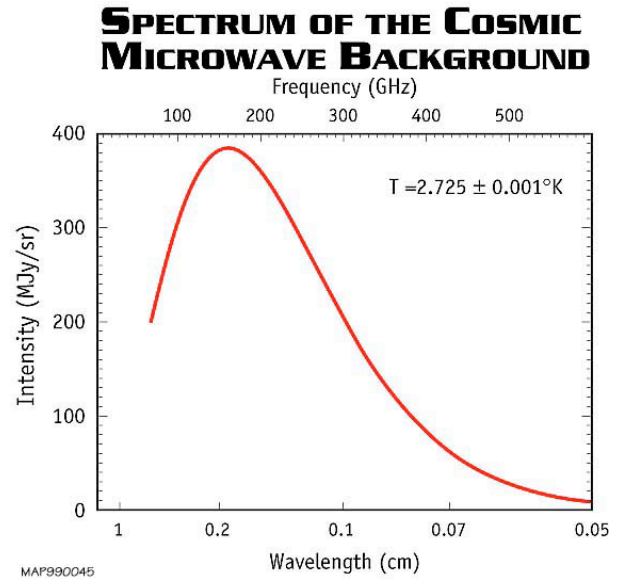

*As measured by the COBE satellite, the CMB exhibits a thermal spectrum with a temperature of 2.725 degrees Kelvin (map.gsfc.nasa.gov).*

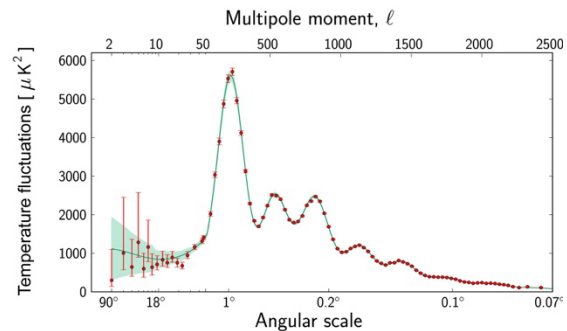
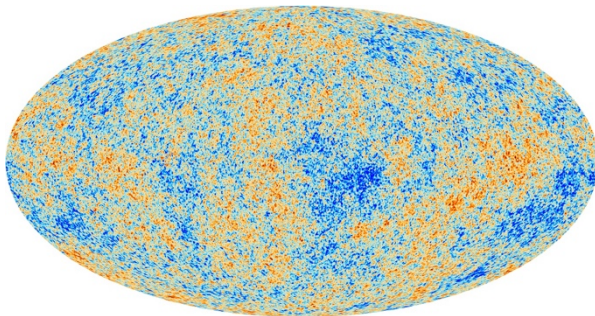

*Map (left) of the departures from a perfect thermal (blackbody) spectrum of the CMB radiation made by the Planck satellite, displayed on a Mollweide projection. Colors delineate regions that are slightly hotter or colder than the average temperature of 2.725 K. The distribution of the sizes of the blotches, called the “power spectrum” (right) sets limits on the expansion history of the universe. Credit: ESA.*

The optical design of CCAT-p delivers a flat focal plane that has the potential to hold a camera with hundreds of thousands to millions of detectors when such a device is developed. Given the rapid pace of advances in sub-millimeter technology, such a device should be developed by within 5-8 years, and CCAT-p will be ready for it. With its exceptional sensitivity and field of view, CCAT-p offers important new ground-based capabilities for probing the subtle details of the CMB: revealing information about the early universe, its expansion history and the characteristics, and the nature of dark energy, dark matter and fundamental particles like neutrinos.

## Probing galaxy clusters with the Sunyaev-Zel'dovich Effect

The rich clusters of galaxies represent the largest scale in the universe on which matter is gravitationally bound. Galaxy clusters contain thousands of galaxies as well as hot intracluster gas seen in X-rays. Studies of the number, mass, nature and distribution of clusters at different epochs of cosmic time provide critical probes of cosmology and the growth of structure as the universe evolves.

In 1970, Rashid Sunyaev and Yakov Zel'dovich predicted that the shape of the CMB spectrum seen toward a cluster of galaxies would be perturbed by the hot intracluster gas as the CMB photons gain energy by scattering off the hot electrons. First observed in 1983, the resulting distortion of the CMB spectrum, illustrated in the diagram to the right and below, is known today as the Sunyaev-Zel'dovich (SZ) effect.

When examined in greater detail, the SZ effect can be assigned to several different causes: the (inverse Compton) scattering off the hot electrons ("thermal": tSZ effect) illustrated in the diagram to the left, another due to the motion of the whole cluster with respect to the cosmic expansion ("kinetic": kSZ effect), and a smaller effect due to the scattering off very hot electrons with relativistic speed ("relativistic": rSZ effect). The net tSZ signature of a cluster does not depend on its distance, so that the SZ effect provides a powerful way to discover distant clusters. Each of the separate SZ effects provides different information about fundamental cluster properties, including the electron density, momentum, optical depth, temperature, velocity, and mass. Cosmological parameters are most sensitive to the mass, redshift, and velocity, motivating precise measurements of clusters to develop unbiased estimates of these quantities.



**Composite image of the hot gas** seen by the Chandra X-ray Observatory (blue) superposed on a Hubble Space Telescope image of a galaxy cluster. Credit: NASA.

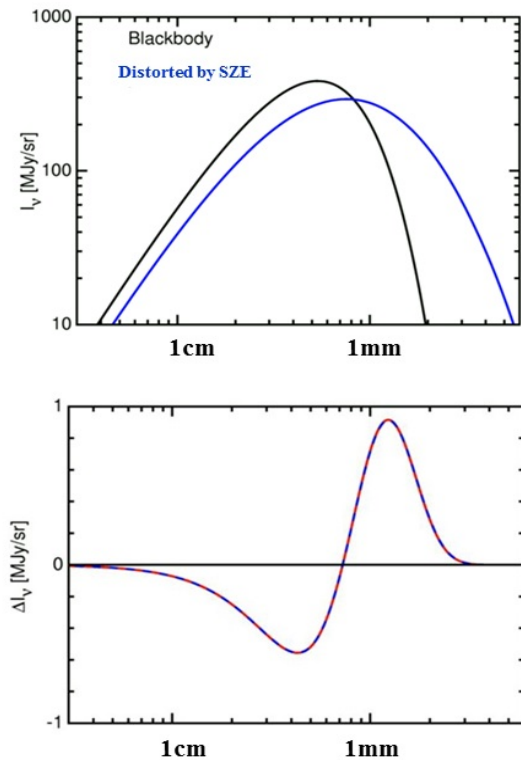

*Top: The original CMB thermal ("blackbody") spectrum is distorted (blue curve) as the photons pass through a foreground cluster. Bottom: The difference between the two (original and distorted) as a function of wavelength; this is what CCAT-p would observe. Adapted from a figure by Ned Wright.*

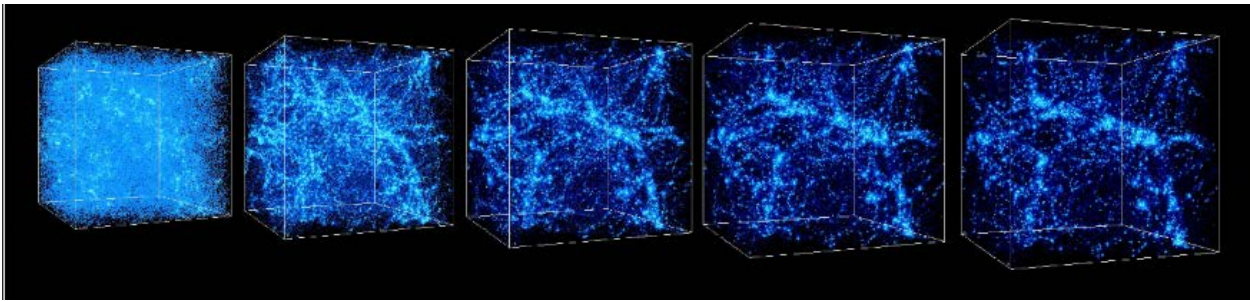

*Numerical simulation of the growth of the large-scale “cosmic web” over cosmic time from the early universe (left) to the present epoch (right). The massive clusters of galaxies form at the intersections of filaments. Because of the large contrast in densities within the criss-crossing network to the nearly-empty voids, clusters are pulled toward the higher densities and away from the lower density ones; these additional motions give the clusters a velocity that is different from what we would expect if their motion was purely dictated by the cosmic expansion. Observations with CCAT-p of the kinetic SZE give the “peculiar velocities” of clusters, in turn revealing the underlying large-scale contributions of dark matter and dark energy within the cosmic web. From [cosmicweb.uchicago.edu](http://cosmicweb.uchicago.edu)*

The Planck satellite has recently performed the first all-sky survey using the SZ effect and has detected more than a thousand clusters by identifying their tSZ signal. (Planck Collaboration 2015, A&A 581, 14). Going beyond the mere detection of distant clusters, CCAT-p is specifically designed to make very precise measurements of their motions and the hot gas temperature by measuring the much smaller distortions caused by the kSZ and rSZ effects. It can also shed light on the yet unexplored intracluster dust.

While, on the large scale, the universe is expanding at an accelerating rate, local deviations from a uniform cosmic expansion arise around regions where the mass density is higher (or lower). For example, near a cluster, galaxies move apart with the cosmic expansion, but are pulled towards the cluster’s mass concentration, so that the galaxies have less expansion velocity than expected. On even larger scales, the motions of the clusters themselves reflect the distribution and nature of dark matter in the cosmic web as well as the influence of the so-called “dark energy”. High precision measurements of cluster motions for large numbers of clusters place stringent constraints on models of how structure grows in the accelerating universe.

Measuring the relativistic corrections to the SZ effect allows breaking of the degeneracy between electron density and temperature and measuring both directly, which would allow for a full thermodynamic description of galaxy clusters. This would greatly benefit cosmological tests with galaxy clusters, since mass estimates would become more robust and independent of other observables. So far, measuring the temperature of clusters has only been possible by observing their X-ray emission, which requires space telescopes and is very challenging at high redshifts.

Simulation of multiwavelength CCAT-p observations and the predicted distinct components of the thermal (tSZ), kinetic (kSZ) and relativistic (rSZ) effects. The colored vertical bars show the observing windows of the planned P-Cam camera from 350  $\mu\text{m}$  to 3 millimeters. Detection of the kinetic SZ effect requires careful separation of the different SZ components as well as the noise contributed by other sources such as submillimeter galaxies, foreground Milky Way dust and the instrument itself. Simulations and figure courtesy of Avirukt Mittal (Cornell).

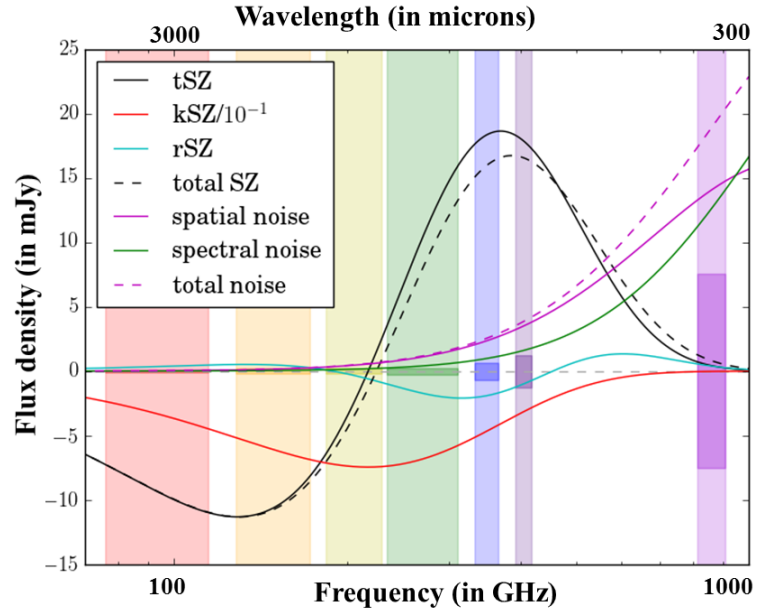

CCAT-p provides a unique combination of wavelength coverage, sensitivity, and resolution that will enable separation of the tSZ, kSZ, and rSZ effects and dust emission (foreground and in the intracluster gas) in thousands of individual galaxy clusters. Current and planned CMB survey instruments are only sensitive to wavelengths longer than 1 mm, while CCAT-p will observe between 350  $\mu\text{m}$  and 3 mm. The shorter wavelengths provide important additional information for isolating these signals, which will in turn lead to significant advances in our understanding of galaxy clusters and in using them to constrain cosmology.

## Tracing the proliferation of the first star forming galaxies during the epoch of reionization

As the universe expanded and cooled after the Big Bang, the Cosmic Microwave Background radiation was emitted when free electrons combined with protons to form electrically-neutral hydrogen atoms and allowing photons to travel unimpeded in the universe, essentially “decoupling” from matter. For the following 500 million years or so, there were no sources of light, no stars, no galaxies; this time period is dubbed the cosmic “Dark Age”. Toward the end of the Dark Age, the first stars formed, “lighting up” the universe at “Cosmic Dawn”. Their photons gave enough energy to free-up the electrons, causing the neutral atoms to ionize. We thus call the time frame when the first star-forming galaxies appeared the Epoch of Reionization (EoR). One of the principal science aims of CCAT-p is to identify when, how and where the first star-forming galaxies appeared and to trace their distribution as a function of cosmic time from the end of the Dark Ages to the time when all of the baryonic material filling the space between the galaxies (the “Intergalactic Medium”) was ionized.



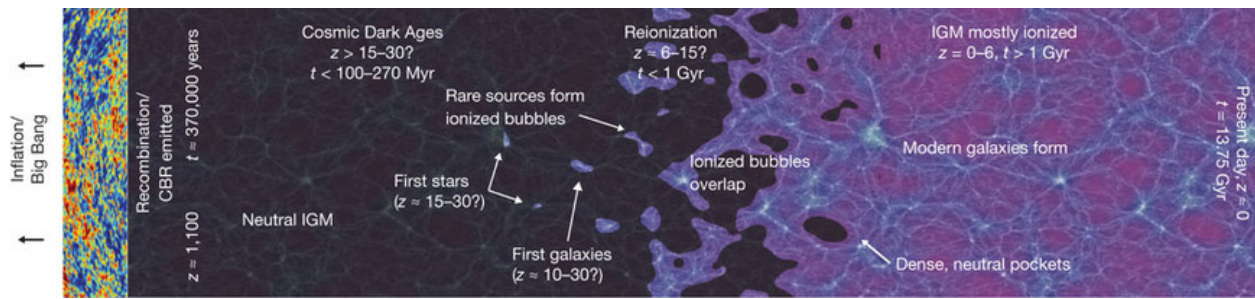

*Schematic diagram of the first billion years of the universe, emphasizing the state of the intergalactic medium (IGM) from the era of Recombination through the Dark Ages to the Epoch of Reionization. During the Dark Ages, the IGM is neutral, but its degree of ionization grows as photons from the first stars and galaxies spread. Probably a first generation of stars is required to form before the first galaxies do; hence the diagram distinguishes between the first stars and the first galaxies. From Robertson et al (2010, Nature 468, 49).*

CCAT-p will identify the appearance and spread of the first star-forming galaxies as they reionized the intergalactic hydrogen that was neutral during the Dark Ages by detecting not the individual galaxies but rather their aggregate signal using a technique called “intensity mapping”. CCAT-p will study ionized carbon, a very useful tracer because of its relatively high abundance and low ionization energy, in the star-formation regions in the early galaxies, targeting the epoch from 500 million to 1 billion years after the Big Bang. Measurement of the topology of the carbon signal as the universe expands will allow us to watch the proliferation of star-forming galaxies and their influence on the surrounding intergalactic medium. A complementary program called the “HI in the Era of Reionization Array” (HERA), will trace the disappearance of the neutral hydrogen, while future infrared observations with the James Webb Space Telescope hope to identify the very first generation of stars responsible for producing the carbon we detect.

In truth, we do not yet understand very much about this era of “Cosmic Dawn” or exactly what the first critical sources of “light” are. While supermassive black holes may also provide high energy photons, they do not appear to be numerous enough to produce the global reionization. Rather, observations with ALMA are already showing the potential for reionization of the highly abundant, normal star-forming galaxies; see the figures on the next page.

In addition to the ionized carbon, studies will also be possible with CCAT-p of other tracers of star-forming galaxies including oxygen, the hydroxyl (OH) molecule and high level transitions of the abundant carbon monoxide (CO) molecule. Mapping the evolution of the topology exhibited by different tracers will allow us to specify in much greater detail the process of reionization and the timescale on which it occurs.

Right: Contours of the ionized carbon [CII] line emission (red) and weak far-infrared continuum emission (blue) as detected by ALMA superposed on rest-frame ultraviolet images of nine “normal” star forming galaxies and one quasar at redshifts of 5-6, corresponding to the epoch about 1.2 billion years after the Big Bang (look-back time of 12.5 billion years). From Capak et al. (2015, *Nature* 522, 455).

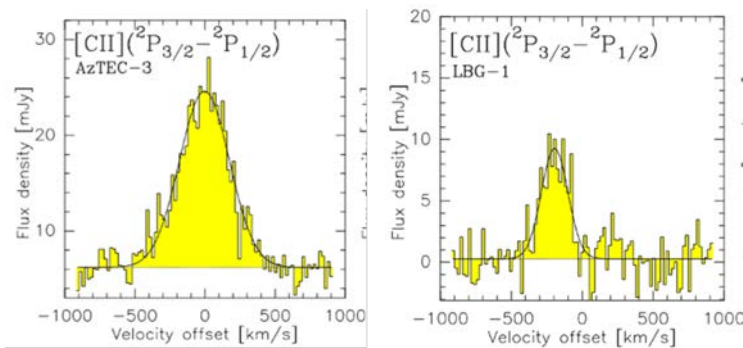
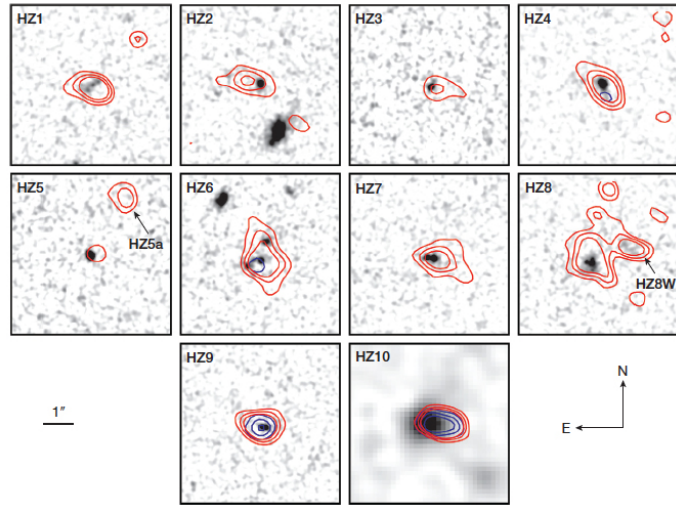

Left: ALMA spectra of the ionized carbon [CII] 158 micron line emission from two galaxies at redshifts of 5.3, corresponding to a time frame about 1.3 billion years after the Big Bang. From Riechers et al. (2014, *ApJ* 796, 84).

## Tracing the Evolution of Dusty Galaxies over Cosmic Time

The evolution of the rate at which galaxies convert their gas into stars reflects the build-up of stars and heavy elements through cosmic history. To date, most high redshift star formation rate measurements are based on rest-frame ultraviolet measurements under not-well-understood assumptions about the impact of dust. ALMA is able to make high resolution images of individual galaxies selected from existing surveys, but understanding the evolution over cosmic time of galaxy populations requires the statistics of comprehensive wide-area surveys extending to the short submillimeter wavelengths. Because of its modest 6-meter aperture, CCAT-p will have limited capability to detect normal star-forming galaxies at redshifts  $z > 2$  because of confusion: the inability to separate emission from multiple galaxies found within a single resolution element (or beam). However, with a confusion limit of 2-3 mJy at 350  $\mu\text{m}$ , the planned Galaxy Evolution (GEvo) survey with CCAT-p will be able to beat most surveys undertaken with the Herschel Space Observatory’s 3.5 meter telescope, both in depth and in survey area. Because of its highly efficient mapping capability, CCAT-p wide-area surveys will be able to reach deeper into the number counts that Herschel, directly resolving and characterizing the population of sources at the faint levels that make up the bulk of the far infrared background and detecting exotic, highly luminous individual objects.

## Tracing the physical properties that lead to star formation in nearby galaxies

On large scales, the interstellar medium is laced with elongated filaments. On much smaller scales embedded within the crisscrossing filaments, stars form when dusty, cold molecular clouds fragment into clumps which then collapse. Once formed, the nascent massive stars heat the surrounding gas, and their winds stop further infall of material; when the massive stars eventually die, their supernovae blow away remaining gas. The interstellar medium is thus a complex, dynamic ecosystem of cooling and heating, collapsing and expanding gas and dust clouds of different sizes, temperatures and densities. Overall, the rate of star formation in a galaxy is governed by the variety of physical processes that take place on physical scales between those within individual molecular clouds and those of entire galactic disks.

The detailed structure of the cloudy, heterogeneous interstellar medium can be deduced by studying a suite of spectral lines arising from the diverse ionized, neutral and molecular components which trace the temperature and density variations. Additionally, spectral lines provide measures of the motions of the gas clouds, revealing the presence of infall or outflow.

Of particular importance to CCAT-p are the fine structure lines of neutral and ionized carbon, oxygen and nitrogen as well as mid- and high-excitation CO lines, since they are agents of cooling in molecular cloud formation or star formation feedback, and therefore important tracers of these processes. In the Milky Way, these lines are hard to observe from the ground, since they occur at submm or far infrared wavelengths. For high-redshifted galaxies however they can get shifted into the ALMA bands, and are by now regularly observed as indicators of star formation activity on galactic scales. In order to relate the global measures of star formation at high redshift measured by ALMA to the relevant physical processes in detail, it is essential to grasp the physics of these lines on the spatial scales accessible in the Milky Way and other nearby galaxies. A thorough understanding of large scale star formation and the related feedback processes is crucial to the development of a self-contained theory of galaxy formation and evolution.



*Contrasting views of the interstellar cloud around the Cocoon Nebula. Upper: far infrared-submillimeter (70, 250 and 500  $\mu\text{m}$ ) image from the Herschel Space Observatory. Redder colors trace the cold gas and dust while the bluer arises from material heated by recently formed stars. Credit: ESA/SPIRE/PACS Gould's Belt Survey. Lower: optical image of the same field showing the ionized gas around the massive stars (red) and the cold (dark) filament. The cold material evident in the Herschel image absorbs the background starlight and thus appears dark in the optical image. Credit: Adam Block/NOAO/AURA/NSF*





*The stars and dust trace the disk of our Milky Way Galaxy across the sky above the ALMA antennas on the Chajnantor plateau.  
Credit: ESO/J.F.Salgado.*

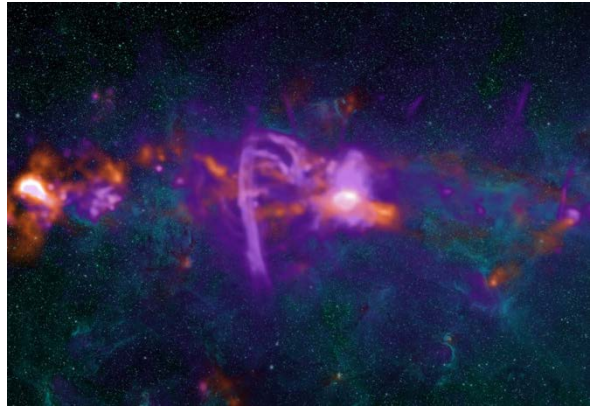

*Combined radio and infrared image of the Central Molecular, containing young massive stars and dense gas and dust.  
Credit: A. Ginsburg & the GLIMPSE team.*

Located at its superb high site, CCAT-p is designed to map wide swaths of the Milky Way, its neighbor galaxies the Large and Small Magellanic Clouds and other nearby galaxies in the submillimeter continuum and in a host of spectral lines. It will have twice the angular resolution of the Herschel Space Observatory and four times that of the airborne telescope SOFIA. The ability of CCAT-p to map large regions will enable the proposed Galactic Ecology (GEco) survey. GEco aims to understand the complex variations in temperature, density, radiation field and motions of the gas and dust involved in the star formation process across a host of local environments representative of the Milky Way's disk, the Central Molecular Zone near the Galactic Center and across the less evolved, lower metallicity volumes of the Large and Small Magellanic Clouds.

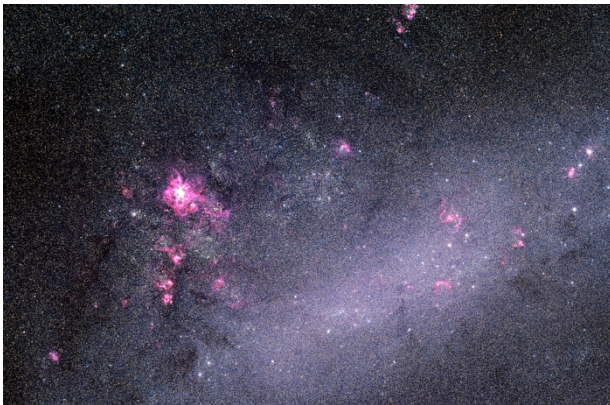

*Close up view of the Large Magellanic Cloud with its vast star forming complex 30 Doradus (pink blotch in left of center).  
Credit: ESO/La Silla*



*The Large (center) and Small (upper right) Magellanic Clouds in the night sky above the ALMA antennas. Credit: ESO/C.Malin*



## Riding the technology wave

Its novel optics design and location at a superb site position CCAT-p to take advantage of the rapidly changing landscape of submillimeter wavelength instrumentation, particularly in areas of detector arrays with very large numbers of pixels, polarization sensitivity, multiobject spectroscopy and high resolution THz spectroscopic mapping. The instrument requirements are set specifically by the science objectives; a first set of instruments that will satisfy the needs of the kSZ, IM/EOR and GEco survey programs as presented in previous sections are planned are:

- A multi-color camera which fills the focal plane of the telescope with a very large number of pixels;
- A multi-element spectrometer designed specifically to yield high spectral resolution mapping of multiple spectral lines at the short submillimeter (terahertz) wavelengths;
- An imaging spectrometer to measure the ionized carbon line (rest wavelength of 158  $\mu\text{m}$ ) at redshifts from 7 to 9 (0.93 to 1.58 mm band) with a spectral resolving power  $RP \sim 500$ ;

Here we outline our vision for the CCAT-p instrument development, starting with a first generation of instruments:

### P-Cam: A wide-field submillimeter-to-millimeter wavelength camera

Because it is necessary for verification of the optical system performance (wavefront accuracy over the field of view, pointing, emissivity, etc.) as well as to enable both the kSZ and GEco science programs, a submillimeter camera capable of delivering images over a range of wavelengths will certainly be a first-light instrument for CCAT-p.

As illustrated schematically below, a first concept, dubbed P-Cam, will have seven sub-camera modules. All but the central short-wavelength module will be interchangeable except for wavelengths-specific subsystems such as anti-reflection coatings on lenses, filters and detectors. P-Cam has  $\sim 1.5 \lambda/D$  pixel sizes with near unit filling factor in the image plane and is diffraction limited at all wavelengths. Scaled to the 6 m CCAT-p telescope, P-Cam will initially deliver a  $1^\circ$  field of view for each subcamera with an overall field of view equivalent to  $\sim 3^\circ$  in diameter.

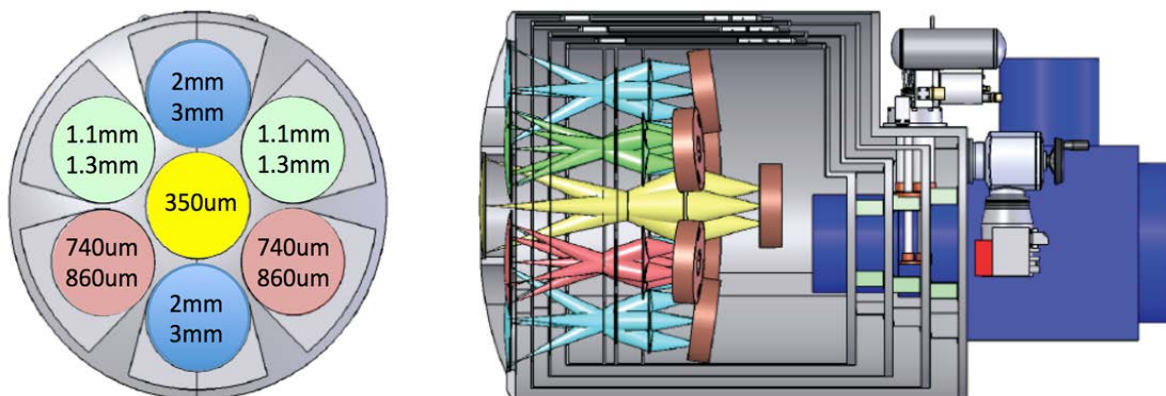

*Possible layout of P-Cam modular camera concept. Numbers on the front view are the wavelengths of each sub-camera. Each subcamera in the ring of six is interchangeable, depending on science optimization.*

The detector technology used in P-Cam could be either Transition-Edge Sensed (TES) bolometers or Kinetic Inductance Detectors (KID) depending on how either of these technologies develops over the next 2-3 years. The TES technology is mature and has delivered background noise-limited performance over the bands of interest in several large-format (few thousand pixels) array cameras. The KID technology is still in development, but the detectors are easier to manufacture and multiplex so that arrays and their readouts are less expensive than TES arrays. The pixel count per  $1^\circ$  diameter FoV scales by one over the wavelength squared:  $n_{\text{pix}} = 20,000 \times (350/\lambda)^2$ . The kSZ survey forecasts are based on a P-Cam concept with one 350 micron camera, two multichroic 740+860 micron cameras, two multichroic 1.1+1.3 mm cameras, and two multichroic 2+3 mm cameras, thereby covering the full range of wavelengths simultaneously.

Longer-term development of even larger, polarization sensitive cameras is a priority of the next-generation ground-based CMB program, and such instruments, with more than half a million detectors at millimeter wavelengths and even more at shorter wavelengths, will likely be available in 5-8 years. Given its large focal, flat plane, CCAT-p will be an obvious platform to host such an instrument and thus CCAT-p can serve as an integral part of the overall next-generation CMB strategic plan.

### **CHAI: The CCAT Heterodyne Array Instrument**

CHAI is a heterodyne receiver, exploiting frequency mixing to detect signals, with focal plane arrays that can observe in the 370 micron (810 GHz) and 610 micron (492 GHz) bands simultaneously. Each array has 64 spatial elements with a goal eventually to have 128 elements. The primary science goals are driven by the GECO survey: to map the CO(7-6) and (4-3) lines as well as the neutral carbon [C I] line pair at 370 and 610  $\mu\text{m}$  simultaneously. Planned surveys will target the central molecular zone near the Galactic Center, the closer-to-us “Gould’s Belt” and the Large and Small Magellanic Clouds in their entirety.

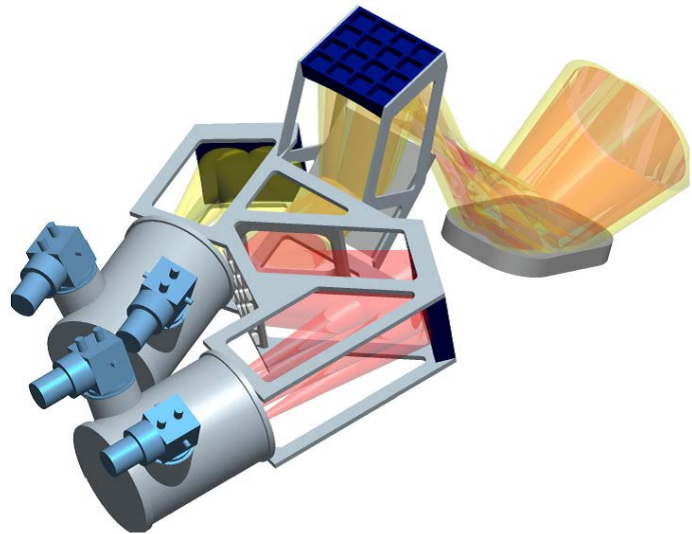

*CHAI optical layout. The two dewars are on the left and the telescope optics are on the right.*

The CHAI design is modular so that changes in mixer technology or frequency bands can be easily achieved. As illustrated in the schematic diagram to the right, there is a separate dewar for each receiver band. At first light, it is envisioned that a lower frequency array operating in the 850 micron window capable of observing the  $^{12}\text{CO}(3-2)$  and  $^{13}\text{CO}(3-2)$  lines will be available.

CHAI is being built at the University of Köln.

## P-Spec: An imaging spectrometer

CCAT-p requires an imaging spectrometer that can operate from the submillimeter to millimeter range in order to undertake the wide area intensity mapping of the redshifted  $158\ \mu\text{m}$  ionized carbon [CII] line at redshifts from 5-9 under the IM/EoR survey described above. The key requirements imposed by the science objectives are: the ability to image large ( $\sim 16\ \text{sq. deg.}$ ) fields of view at high sensitivity (noise level  $\sim 0.4\ \text{mJy/beam}$ ) with better than 1 arcmin beams in the 0.97 to 1.58 mm wavelength bands at a spectral resolving power of about 500 within a reasonable ( $< 4000\ \text{hrs}$ ) integration time on the sky.

A suitable imaging spectrometer can be constructed in several ways, and technology development in this arena is developing rapidly. An initial simple approach would turn individual tubes of the imaging camera P-Cam into an imaging Fabry-Perot interferometer (FPI). First demonstrated in 1899 by Charles Fabry and Alfred Perot, FPI uses a set of reflecting surfaces and multiple reflections off them to isolate wavelengths of light. Implementation of the FPI capability is straight-forward and would be accomplished by inserting such a device into the appropriate location in the optical path of one, or several of the P-Cam sub-camera units. Each 6 arcmin diameter FoV camera at 1.2 mm wavelength has about 1000 pixels. A single sub-camera might kick off the studies, with tubes added to deliver a combined FPI mapping speed that would meet the needs of the IM/EOR program.

The Cornell instrument team has considerable experience in the design and construction of a wide variety of FPI that have been used for astrophysics across the wavelength range from  $30\ \mu\text{m}$  to the submm bands. One FPI developed at Cornell has been used on the 15 meter James Clerk Maxwell Telescope and the 1.7 meter AST/RO telescope at the South Pole to map submillimeter spectral line emission in the Galactic Center, the Carina Nebula and nearby infrared-bright galaxies.

This initial spectrometer, P-Cam(+FPI), will enable the first IM/EOR experiments. If enough beams can be put on the sky, a future approach would employ a multiple beam spectrally multiplexing grating spectrometer; such devices are under development with likely delivery of the necessary capability for a second generation spectrometer at a reasonable cost still some years off.

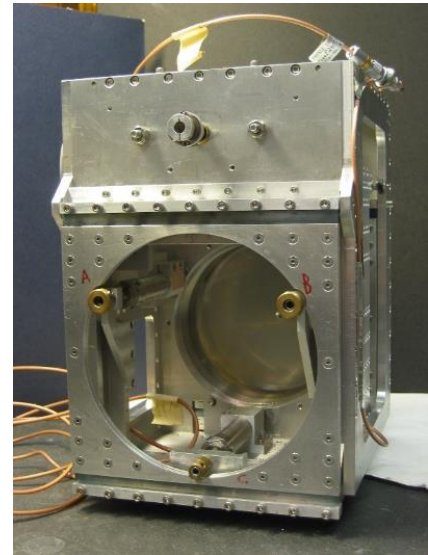

*Previous generation submillimeter FPI developed at Cornell (Courtesy M. Bradford and G. Stacey).*



## Geographic Location

The Atacama desert is a strip of land 1000 miles long to the west of the Andes mountains on the Pacific coast of Chile. The Chajnantor plateau (Llano de Chajnantor), site of ALMA, and the peaks surrounding it, are located to the east of the village of San Pedro de Atacama. Normally, we get to San Pedro via a 2-hour flight from the capital Santiago to the city of Calama, and then a ride of about 100 km to San Pedro. The map below, adapted from Google Maps, is intended to illustrate the scale of distances between these locations.



217 km: Antofagasta to Calama (2260 meters)  
 100 km: Calama to San Pedro de Atacama (2400 meters)  
 50 km: San Pedro de A. to ALMA OSF (2900 meters)  
 28 km: ALMA OSF to AOS (5000 meters)

The map below, adapted from one made from Thematic Mapper Satellite data, shows the location of San Pedro, the ALMA array and the nearby peaks, C. Toco, C. Chajnantor and C. Chascon. CCAT-p will be built just below the summit of C. Chajnantor, overlooking ALMA.

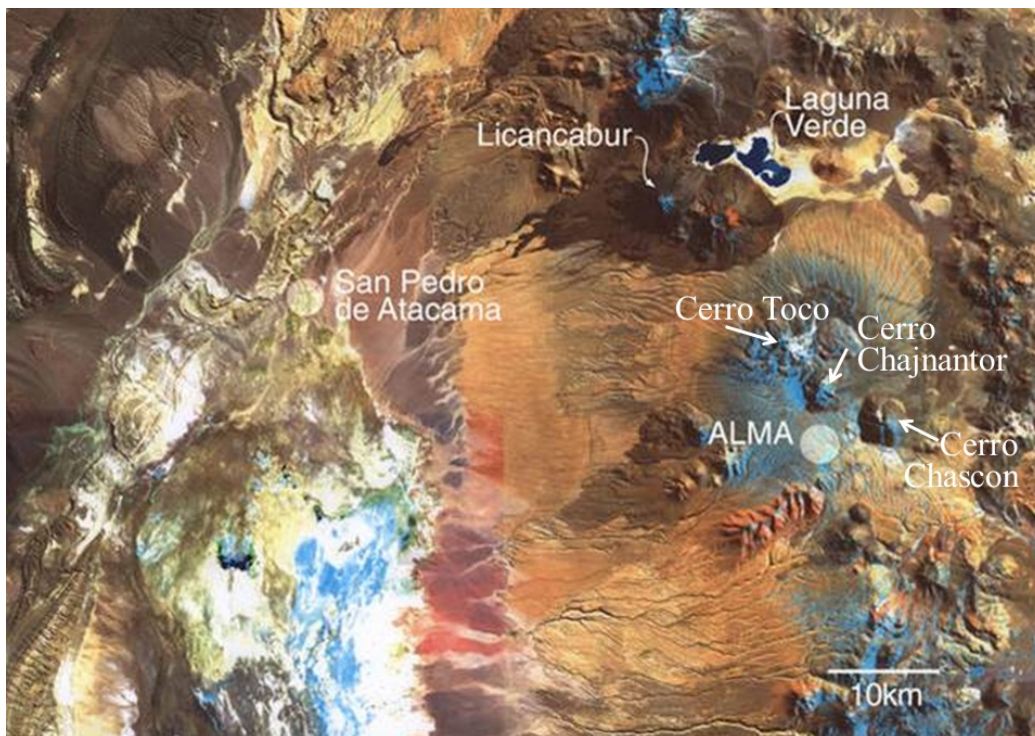



## Astronomy in the Atacama Altiplano

The broad Chajnantor plateau at 5000 meters elevation hosts the Atacama Large Millimeter Array (ALMA), an array of 54 12-meter diameter and 12 7-meter diameter antennas built and operated by a global partnership of countries in Europe, North America and East Asia and hosted by the Republic of Chile. The location of CCAT-p in close proximity to ALMA offers potential logistical advantages; CCAT-p will certainly benefit from the experience of ALMA construction and operations.



*Cerro Chajnantor looms high above the plateau at 5000 meters where ALMA is located.*

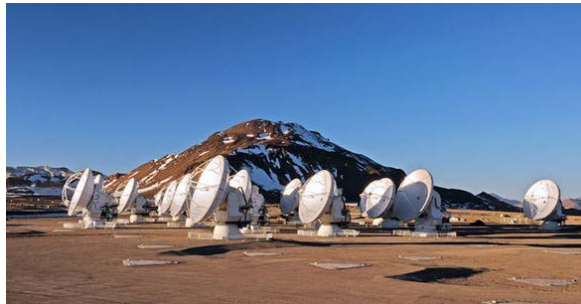

*An Interferometric array, ALMA specializes in making high resolution, exquisitely detailed images of small patches of the sky.*



*The ALMA control center, at 5000 meters, with Cerro Chajnantor rising to 5 in the background.*

Other astronomical facilities are also located in the Chajnantor region. The Atacama Pathfinder Experiment (APEX) is a 12-meter diameter submillimeter telescope that is operated as a single dish separate from ALMA. The Atacama Cosmology Telescope (ACT) and the Simons Array, as part of the future Simons Observatory, perform studies of the Cosmic Microwave Background at millimeter wavelengths, from a site at 5200 meters on Cerro Toco. The Tokyo Atacama Observatory (TAO) is constructing a 6.5 meter infrared telescope on the summit of Cerro Chajnantor, 100 meters above the CCAT-p site.



*APEX is a collaboration of the Max Planck Institute for Radioastronomy (Germany), the Onsala Space Observatory (Sweden) and the European Southern Observatory.*



*The Atacama Cosmology Telescope (ACT) and the Simons Array are part of the Simons Observatory, a collaboration of Princeton, UPenn., UC San Diego, UC Berkeley and the Lawrence Berkeley National Laboratory, supported by the Simons Foundation.*

## The CCAT Partnership

CCAT-p is being constructed as a partnership of Cornell University, a consortium of German institutions led by the Universities of Köln and Bonn, and a consortium of eight Canadian academic institutions. Researchers at additional institutes in the U.S., Canada, Germany and Chile are involved in science planning and instrument development. CCAT operates in Chile thanks to a Cooperative Agreement with the University of Chile and under the auspices of the Ministry of Foreign Affairs.

The CCAT Observatory is operated as a joint venture between the CCAT Corporation (a no-share 501(c)(3) not-for-profit organization) and the Canadian Atacama Telescope Consortium (CATC), a no -share capital corporation incorporated by a group of Canadian universities under the laws of Canada as a registered charity under the Canada Income Tax Act.

The CCAT collaboration is open to discussion with additional potential partners interested in participating in CCAT-prime science and technology development programs.

*Cerro Chajnantor looms above the ALMA plateau at 5000 meters. The white speck at the top-left of the mountain is the dome of a small optical-infrared telescope installed by the Tokyo Atacama Observatory (TAO) team as part of their feasibility study for their 6.5 meter infrared telescope now under construction. Although it will have a protective shutter, CCAT-p will not be in a dome; its location on a ridge about 100 meters below the summit is naturally shielded from the prevailing westerly winds.*



*View from the CCAT site toward the south. The shadows of clouds are seen falling on the plateau below at 5000 meters where ALMA is located. The whitish serpentine tracks are the roadways connecting the ALMA antennas.*

## Glossary of Acronyms and Terms

**ACT:** Atacama Cosmology Telescope, an existing 6-meter telescope located at 5200 on Cerro Toco used to study the Cosmic Microwave Background (CMB) radiation. Like the crossed-Dragone design planned for CCAT-p, the mirrors are placed so that there is no blockage, but in the case of ACT, the field of view is only 1 degree across.

**ALMA:** The Atacama Large Millimeter/submillimeter Array, the global flagship array of antennas for submillimeter and millimeter wavelength astronomy.

**AOS:** Array Operations Site, the ALMA work area near the center of the array on the Chajnantor plateau at 5000 meters. The AOS hosts the digital correlator which performs the first processing of signals arriving from the individual antennas before transferring the data down to computer facilities at the OSF, about 28 km away. Work requiring performance at the 5000 meter site is kept to a minimum because of the altitude.

**APEX:** Atacama Pathfinder Experiment, a 12-meter telescope located on the ALMA plateau but used independently of ALMA.

**Arcmin** or **arc minute:** 1/60th of a degree.

**Arcsec** or **arc second:** one second of arc, 1/60th of an arc minute, or 1/3600th of a degree.

**AUI:** Associated Universities, Inc., a not-for-profit corporation based in Washington, D.C. which was established by nine northeastern U.S. universities (including Cornell) to construct and manage major scientific facilities. AUI manages the National Radio Astronomy Observatory under a cooperative agreement with the National Science Foundation and is the executive for the North American partnership engaged in ALMA.

**Baryons:** Matter made of neutrons, protons, electrons, etc. (“normal”).

**Bolometer:** A detector commonly used in submillimeter and millimeter wave astronomy which functions by measuring the temperature increase caused by the radiation that strikes it.

**Cerro Chajnantor:** Peak to the northeast of the ALMA AOS on the Chajnantor plateau hosting the CCAT and TAO sites.

**Cerro Toco:** A peak to the north of the Chajnantor plateau which hosts several CMB experiments including ACT and the planned Simons Observatory.

**Chajnantor plateau:** a broad, roughly flat plateau at an elevation of 5000 meters, where ALMA is located. Also called the Llano de Chajnantor.

**[CII]:** Singly ionized Carbon atom (i.e., one electron has been lost), sometimes also indicated as C<sup>+</sup>. The [CII] fine structure line at a rest wavelength of 158 μm is a major coolant of many phases of the neutral and ionized ISM. The observed emission can be attributed to photon-dominated regions (PDRs), diffuse HII regions, diffuse interstellar clouds, and CO-dark molecular gas at the boundaries of molecular clouds. This line can thus trace many different conditions in the interstellar medium, giving measures of the gas heating efficiency and temperature, the strength of the local interstellar radiation fields (the number of nearby ionizing stars) and the total gas density.

**CMB:** Cosmic Microwave Background, a remnant radiation field the properties of which were determined by the physical conditions of the Universe at the Epoch of Recombination, at which free electrons and protons first combined to form neutral Hydrogen atoms, some 380,000 years after the Big Bang. Its spectrum is that of an almost perfect black body, which due to the cosmic expansion is now observed to have a temperature of 2.73 Kelvin. Fluctuations about that value are detected across different lines of sight, the study of which are used to quantify cosmological parameters.

**Cosmic expansion:** The growth in the average distance between galaxies as the universe expands.

**Cosmic time:** Timescale of the history of the universe, starting with the Big Bang and extending to the present (and potentially into the future).

**Crossed-Dragone design:** A telescope optical design which makes use of several large, nearly flat mirrors to produce a very flat focal plane with a very large field of view, no blockage and high efficiency.

**Dark Age:** The interval between the epoch of recombination and the epoch of re-ionization. It ends when the first stars and star-forming galaxies form, a few hundred million years after the Big Bang.

**Epoch of Recombination:** Epoch at which the Universe has cooled sufficiently, thus making it possible for free electrons and protons to combine, forming neutral atoms, and stay combined. This process at about 400,000 years after the Big Bang gave rise to the Cosmic Microwave Background (CMB) radiation.

**Epoch of Re-Ionization (EOR):** Epoch at which the radiation produced by the first stars and star-forming galaxies causes the neutral Hydrogen in the intergalactic space to become ionized.

**Fabry-Perot Interferometry (FPI):** A method of spectroscopy exploiting multiple reflecting plates in order to measure and isolate specific wavelengths of light.

**Fine structure lines:** Spectral lines arising from differences in quantum mechanical states separated by spin and orbital effects.

**Focal ratio or f-ratio:** Ratio of the focal length of telescope to the diameter of the primary mirror.



**Half wavefront error (HWFE):** The aberration in the arrival of a wave from what would be expected in a perfect optical system. A large value means that the wave is seriously deformed as it passes along the optical path.

**HERA:** A set of international facilities under development with the goal to detect the 21 cm spectral line of atomic Hydrogen emitted by neutral atomic gas in the Dark Age, thus redshifted to meter wavelengths, and to trace the disappearance of the signal during the Epoch of Re-ionization as the first stars and star-forming galaxies light up the Universe.

**Heterodyne receiver:** A method of detecting signals commonly used in radio, millimeter and submillimeter astronomy by combining in a non-linear way the incoming radiation with radiation of a known frequency. The result is a lower frequency electrical signal that can be easily decamped into its constituent frequencies.

**IGM:** Intergalactic Medium, the gas – mainly Hydrogen and Helium – that fills the space between the galaxies.

**IM:** Intensity Mapping, the technique used to map the topology of the aggregate emission of radiation from populations of galaxies at different frequencies, corresponding to different redshifts and therefore, different times in cosmic history; time snapshots of the cosmic radiation field.

**ISM:** Interstellar medium, the gas and dust in between the stars in a galaxy.

**Kavli/US Radio 2300 Futures:** A series of 3 workshops sponsored in part by the Kavli Foundation to foster development of a long range strategy for US Radio Astronomy with an eye on the Astro 2020 decadal survey. See <http://www.cvent.com/events/u-s-radio-millimeter-submillimeter-science-futures-ii/event-summary-b7c37ec376c44055b80cfb2f5ef030b5.aspx>

**Llano de Chajnantor:** The Chajnantor plateau at an elevation of about 5000 meters above sea level; location of the ALMA array.

**Magellanic Clouds:** Two nearby galaxies, the Large Magellanic Cloud and the Small Magellanic Cloud, visible to the naked eye from the southern hemisphere and located at about 150,000 light years from the Milky Way.

**Maunakea:** Astronomical facility located on the summit of Maunakea in Hawaii; the site of numerous optical, infrared and radio telescopes including the 15-m James Clerk Maxwell Telescope which operates at submillimeter wavelengths.

**Micron ( $\mu\text{m}$ ):** One millionth ( $10^{-6}$ ) of a meter. Also commonly referred to as “micrometer”.

**OSF:** Operations Support Facility, the main base camp supporting the ALMA observatory. Located at 2900 meters and about 50 km southeast of San Pedro de Atacama, most ALMA support staff, including the array operators who conduct the observing programs, work at the OSF.

**P-Cam:** The multi-color imaging camera planned for CCAT-p.

**P-Spec:** The imaging spectrometer planned for CCAT-p. An initial approach may build on P-Cam, adding a spectral capability via Fabry-Perot Interferometry.

**PUC:** Pontificia Universidad Catolica de Chile, also known as “Catolica”. Highly ranked (Number 2 in Latin America by “The Economist”), private university located in Santiago, with a large Astro-Engineering effort, as well as in Cosmology and Astrophysics.

**PWV:** Precipitable Water Vapor; the thickness of the liquid water layer along a vertical line of sight, that would result if all the water vapor from the ground and up would liquefy. It is generally expressed in millimeters. The PWV atop Cerro Chajnantor is lower (better) than 0.6 mm for as much as 50% of the time.

**RMS:** Root mean square, the square root of the arithmetic mean of the squares of a set of numbers. Also called the quadratic mean.

**Simons Observatory:** A collection of small telescopes, some working independently and some configured as an array, under construction at the 5200 m site on Cerro Toco, largely funded by the Simons Foundation to pursue studies of the CMB.

**South Pole Telescope:** A 10-meter diameter submillimeter telescope located at the NSF’s base at the South Pole.

**Spectral resolving power:** The degree of detail that can be discerned in a spectrum, usually expressed as the ratio of the wavelength to the wavelength range of an individual spectral element.

**Submillimeter:** Spectral range of electromagnetic radiation of wavelength between 0.1 and 1 millimeters (or 100 to 1000  $\mu\text{m}$ ).

**TAO:** Tokyo Atacama Observatory being built by the Tokyo Astronomical Observatory, a Japanese astronomical institute. TAO is planning to build a 6.5-meter infrared telescope on the summit of Cerro Chajnantor, about 100 meters higher than the CCAT site.

**Temperature Inversion Layer:** In the lower layers of the atmosphere, the temperature normally decreases with altitude. In some cases, more often over valleys and plateaus, the trend is reversed and the temperature increases with altitude. The range of altitudes over which this inversion takes place bounds a Temperature Inversion Layer. Most of the atmospheric water vapor is usually “trapped” below such a layer when one forms. A temperature inversion layer is often seen above the Chajnantor Plateau, typically at altitudes of a few kilometers above the plateau elevation of 5000 meters. At night, the inversion layer falls to lower altitudes, sometimes as low as a few hundred meters. When this occurs, sites atop mountains such as Chascon and Chajnantor are above the inversion layer and experience extremely dry conditions.

**THz:** Terahertz =  $10^{12}$  Hz, corresponding to about 300  $\mu\text{m}$  in wavelength.

**UC:** Universidad de Chile. Prestigious public university, with the first, oldest Astronomy Department in the country, housed in the grounds of Cerro Calan Observatory in the suburbs of Santiago.

**WV Scale Height:** Water Vapor Scale Height. On average, the atmospheric water vapor content drops exponentially with altitude, i.e. in proportion of  $e^{-h/H}$  where  $h$  is the altitude and  $H$  is the scale height.  $H$  is generally expressed in meters, with a high value indicating greater transparency.

**Zenith Optical Depth:** A quantitative measure of the degree of transparency to wavelength of a certain wavelength in the zenith (directly overhead) direction above a site. The optical depth (or thickness) is the natural logarithm (base  $e$ ) of the ratio of the incident radiant flux at the top of the atmosphere ( $I_{\text{cosmic}}$ ) to that received at the telescope site ( $I_{\text{ground}}$ ). Mathematically, at some wavelength  $\lambda$ ,  $I_{\text{ground}} = I_{\text{cosmic}} e^{-\tau}$ , where  $\tau$  is the optical depth at that wavelength. Note that  $\tau$  is dimensionless. Small value values mean greater transparency.

Version: 9 August 2017  
Contact: Martha Haynes  
Formatted: Aug 2017; J. Tarbell